

Data sheet | Item number: 400-490/490-004

Stud terminal block; 185 mm²; copper; with 2 stud bolts M12; 185,00 mm²;
light gray

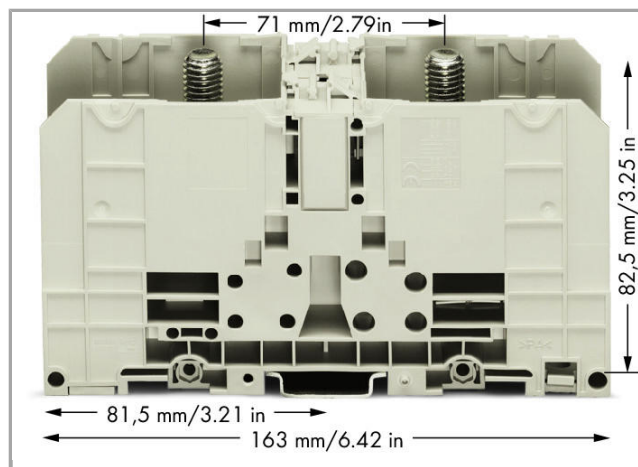

400-490_490-004



Data

Electrical data

Ratings per IEC/EN 60664-1

Rated voltage (III / 3)	1000 V
Rated impulse voltage (III / 3)	8 kV
Rated current	353 A

Connection data

Connection technology	Screw-clamp connection/Studs
Actuation type	Operating tool
Connectable conductor materials	Copper
Total number of connection points	2
Total number of potentials	1
Number of levels	1
Type of wiring	Side-entry wiring

Geometrical Data

Width	55 mm / 2.165 inch
Height from upper-edge of DIN-35 rail	82.5 mm / 3.248 inch
Depth	163 mm / 6.417 inch

Mechanical data

Type of mounting	DIN-35 rail
------------------	-------------

Material Data

Color	light gray
-------	------------

Weight	568 g
--------	-------

Commercial data





Country of origin	FR
-------------------	----















GTIN	4045454706319
------	---------------



Customs Tariff No.	85369010000
--------------------	-------------

Compatible products



Marking accessories

	Item no.: 2009-115 WMB-Inline; for Smart Printer; on reel; stretchable 5 - 5.2 mm; plain; snap-on type; white	2009-115
	Item no.: 2009-115/000-002 WMB-Inline; for Smart Printer; on reel; stretchable 5 - 5.2 mm; plain; snap-on type; yellow	2009-115 /000-002
	Item no.: 2009-115/000-006 WMB-Inline; for Smart Printer; on reel; stretchable 5 - 5.2 mm; plain; snap-on type; blue	2009-115 /000-006
	Item no.: 2009-115/000-007 WMB-Inline; for Smart Printer; on reel; stretchable 5 - 5.2 mm; plain; snap-on type; gray	2009-115 /000-007
	Item no.: 2009-115/000-012 WMB-Inline; for Smart Printer; on reel; stretchable 5 - 5.2 mm; plain; snap-on type; orange	2009-115 /000-012
	Item no.: 2009-115/000-017 WMB-Inline; for Smart Printer; on reel; stretchable 5 - 5.2 mm; plain; snap-on type; light green	2009-115 /000-017
	Item no.: 2009-115/000-023 WMB-Inline; for Smart Printer; on reel; stretchable 5 - 5.2 mm; plain; snap-on type; green	2009-115 /000-023
	Item no.: 2009-115/000-024 WMB-Inline; for Smart Printer; on reel; stretchable 5 - 5.2 mm; plain; snap-on type; violet	2009-115 /000-024
	Item no.: 793-501 WMB marking card; as card; not stretchable; plain; snap-on type; white	793-501



	Item no.: 793-501/000-002 WMB marking card; as card; not stretchable; plain; snap-on type; white	/000-002	793-501
	Item no.: 793-501/000-005 WMB marking card; as card; not stretchable; plain; snap-on type; white	/000-005	793-501
	Item no.: 793-501/000-006 WMB marking card; as card; not stretchable; plain; snap-on type; white	/000-006	793-501
	Item no.: 793-501/000-007 WMB marking card; as card; not stretchable; plain; snap-on type; white	/000-007	793-501
	Item no.: 793-501/000-012 WMB marking card; as card; not stretchable; plain; snap-on type; white	/000-012	793-501
	Item no.: 793-501/000-017 WMB marking card; as card; not stretchable; plain; snap-on type; white	/000-017	793-501
	Item no.: 793-501/000-023 WMB marking card; as card; not stretchable; plain; snap-on type; white	/000-023	793-501
	Item no.: 793-501/000-024 WMB marking card; as card; not stretchable; plain; snap-on type; white	/000-024	793-501
	Item no.: 793-5501 WMB marking card; as card; for terminal block width 5 - 17.5 mm; stretchable 5 - 5.2 mm; plain; snap-on type; white		793-5501
	Item no.: 793-5501/000-002 WMB marking card; as card; for terminal block width 5 - 17.5 mm; stretchable 5 - 5.2 mm; plain; snap-on type; yellow	/000-002	793-5501
	Item no.: 793-5501/000-005 WMB marking card; as card; stretchable 5 - 5.2 mm; plain; snap-on type; red	/000-005	793-5501
	Item no.: 793-5501/000-006 WMB marking card; as card; stretchable 5 - 5.2 mm; plain; snap-on type; blue	/000-006	793-5501
	Item no.: 793-5501/000-007 WMB marking card; as card; stretchable 5 - 5.2 mm; plain; snap-on type; gray	/000-007	793-5501
	Item no.: 793-5501/000-012 WMB marking card; as card; stretchable 5 - 5.2 mm; plain; snap-on type; orange	/000-012	793-5501
	Item no.: 793-5501/000-014 WMB marking card; as card; stretchable 5 - 5.2 mm; plain; snap-on type; brown	/000-014	793-5501

	Item no.: 793-5501/000-017 WMB marking card; as card; stretchable 5 - 5.2 mm; plain; snap-on type; light green	/000-017	793-5501
	Item no.: 793-5501/000-023 WMB marking card; as card; stretchable 5 - 5.2 mm; plain; snap-on type; green	/000-023	793-5501
	Item no.: 793-5501/000-024 WMB marking card; as card; stretchable 5 - 5.2 mm; plain; snap-on type; violet	/000-024	793-5501

General accessories

	Item no.: 400-405/405-770 Control cable connection with screws; for flat tabs; 6.35 x 0.8 mm; for high-current terminal blocks with 2 stud bolts M12	/405-770	400-405
	Item no.: 400-490/490-019 Protective cover; IP20; for high current terminal blocks with 2 stud bolts M12 or M16; light gray	/490-019	400-490

Jumper

	Item no.: 400-405/405-778 Jumper bar with screws; 2-way; for high current terminal blocks with 2 stud bolts M12 or M16	/405-778	400-405
	Item no.: 400-405/405-779 Jumper bar with screws; 3-way; for high current terminal blocks with 2 stud bolts M12 or M16	/405-779	400-405

Downloads

Documentation

Additional Information

Technical explanations	Apr 3, 2019	pdf 2.1 MB	Download
------------------------	-------------	---------------	----------

CAD/CAE - Smart Data

EPLAN

EPLAN Data Portal	Download
-------------------	----------

WSCAD

WSCAD Universe	Download
----------------	----------



Subject to changes.
